



Hydrology

Meteorology

Argo Meteorology

Soil & Plant Sciences

Product Catalogue



Automatic Weather Station



“Virtual” make Automatic Weather Station is a fully computerized, digital and self contained power source system, fitted with Data Logger and battery charging solar panel with rechargeable, maintenance free batteries complete with sensors mounted on a tripod stand with sealed waterproof IP65 enclosure for Data Logger, Solar charger and battery.

Features:

- Display: 16 Characters X 2 Lines alphanumeric display,
- Keyboard: 4x2 membrane keypad for onsite programming of data logger.
- Measured Parameter – **Date, Time, Sensors data, & Battery Voltage.**
- Real Time Clock accuracy: Internal with ± 2 minutes / year & leap year
- Number of Channels: 16 can be extendable (at extra cost)
- Channels Configuration: Factory configured sensors as per purchase order.
- Logging Interval: 1 min to 24 Hr program log Start time within next 24 hours
- Data Storage: store 1 year data at user’s selectable 1 hour logging interval.
- Operating Temperature: - 40 to 75 °C. Humidity: 0 to 95 % non-condensing.
- Power Supply: 12V SMF battery, Charging: Solar Panel / 220V AC (Optional).
- Battery Life: More than 1.5 Years (Easily Available in local Market)
- Solar Panel:: 12 Volt DC, Wattage: 10, 20 & 40 Watt (as per system power requirement)
- Mast: **Default**-Stainless Steel Tripod (SS). **Optional** – 3M SS /6meter GI Mast (at extra cost)
- Data retrieval: Data shuttle (default) to Computer. Other options also available (at extra cost).

Application Software (Virtualware)

This is a user-friendly, Menu Driven, Windows based software allows you to view & save collected data from data logger to computer/laptop. Data file is saved in Microsoft’s Excel format. Also available with data file option for Windrose Software (at extra cost)

Other options: Ethernet, RS-485, RS-232, VSAT, 2G/3G/4G enabled Web based telemetry at Virtual’s Portal “www.ehydromet.in”.

Sensors selection Guide for AWS (limited to channels availability):

- Air Temperature & Relative Humidity
- Wind Speed Sensor (3-Cup type)
- Wind Direction Sensor (Vane Type)
- Wind Speed & Direction (Ultrasonic Type)
- Rainfall Sensor
- Barometric Pressure Sensor
- Solar Radiation Sensors
- Pyranometers
- Pyranometers with Shading Ring Assembly
- Albedometers
- 2 / 4-Component Net Radiation Sensors
- Pyrgeometer
- Pyrheliometer (with /without solar tracker)
- Ultraviolet Sensor
- Infrared Sensor
- Quantum Sensor
- Line Quantum Sensor
- PAR Sensor
- Fog Sensor
- Visibility Sensor
- Passive Cloud Cover
- Snow Water Equivalent
- Ultrasonic Snow Depth
- Soil Moisture Sensor
- Soil Temperature
- Leaf Wetness Sensor
- Water Level (Shaft Encoder Type)
- Water Level (Pressure Type)
- Water Level (Radar Type)
- Water Level (Bubbler Type)
- Water Temperature Sensor
- Road Temperature Sensor
- Infrared Remote Temperature
- PV Module Temperature Sensor
- Evaporation Sensor
- CO₂ Sensor
- NO₂ Sensor
- O₂ Sensor
- PM 2.5 and many more...



Ordering Guide:

SN	Description	(With SS small Tripod Stand) Model No.	(With SS Tripod Stand) Model No.	(With GI Mast) Model No.
1	AWS with Data Shuttle option	AWS-VH-SS-D	AWS-VH-SS2-D	AWS-VH-GM-D
2	AWS with Ethernet option	AWS-VH-SS-E	AWS-VH-SS2-E	AWS-VH-GM-E
3	AWS with 2G/3G/4G WEB-based Telemetry	AWS-VH-SS-GPRS	AWS-VH-SS2-GPRS	AWS-VH-GM-GPRS

Rainfall / Precipitation Gauges

Ordinary Rain Gauge:

The 'Virtual' make Non recording Rain Gauges are manufactured as per IS:5225:1969. Rain Gauge is manufactured from non corrosive fiber glass reinforced plastic container. It consists of collector assembled with brass Ring, Funnel, Locking Rings and Base. The Rain Gauge is supplied with 4 liter bottle and a Plastic measuring cylinder. Rain Gauges are available in 200cm² collection area. The essential parts of an ordinary rain gauge are a funnel through which the rain water is collected in a receiver and a measuring cylinder (rain measure) with which the rain water collected is measured. The correct type of rain measure suitable to the type of rain gauge in use has to be used for the measurement of rainfall. The rain measure 10mm / 20 mm is graduated for every 0.2 mm of rainfall. This instrument is also available with IMD Pune, certification (at extra cost).



Self Recording Rain Gauge:

The 'Virtual' make Self recording Rain Gauges are manufactured as per IS:5225 :1969. Rain Gauge is manufactured from non corrosive fiber glass reinforced container. Recording rain gauges are used to obtain a continuous record of daily or weekly rainfall. It consists of a funnel-shaped collector at the top of the gauge and a float syphon chamber and recording mechanism just below it. the rain water collected by the collector is led into the float chamber. The float is having a central stud on which a pen assembly is fixed. The pen is moving over a daily chart wound over a clock drum. After every 10 mm of rainfall syphoning occurs and recording of rain starts afresh. Supplied with Quartz Clock and Charts for One year.



Rainfall Event Logger (Tipping Bucket):

This data logger (Model: Rainlog) connects to most standard tipping-bucket rain gauges and records rainfall rates, times, and duration as well as momentary contact events and temperature. Because event data is stored when it happens, memory is efficiently used. Data can be viewed in inches or millimeters. Tips are logged with time-stamps to gauge rainfall intensity, and the lockout feature eliminates false readings from tipping-bucket bounce. One year capacity – both logger and battery supply. One minute time/date stamp resolution. Flash memory. USB connectivity. Windows® software included.



Digital Rainfall Recorder (Telemetry Based):

"Virtual" make Digital Rainfall Recorder (Tipping Bucket Type) is a fully computerized, digital and self contained power source system, fitted with Data Logger and battery charging solar panel with rechargeable, maintenance free batteries complete with sealed waterproof enclosure for Data Logger, Solar charger and battery. It comes with facility to transport Data from Data Logger to a Computer (Telemetry or Non -Telemetry). 16x2 LCD alphanumeric display and 4x2 membrane keypad is provided at front panel of data logger for programming data logger and monitoring sensor reading at site without the help of computer. A tipping bucket (cup) mechanism that triggers a magnetic reed switch once every unit of rainfall. Every pulses by Tipping bucket is counted by Data Logger . Data file is saved in Microsoft's Excel.



Solar Measurement

Hand Held Digital Pyranometer:

In this instrument one pyranometer sensor (Shortwave / Global Radiation (Choose Any one)) will be attached with this handheld terminal for the collection of real time data Manually/automatically (user selectable). The terminal has its internal memory along with, a real time clock with an LCD (16 X 2) to display the instrument status. It is a self-contained power source system, fitted with 2XAA Alkaline type batteries with battery level display, complete with sensor.

Deliverables

1. Pyranometer Sensor with 1m cable length
2. Programmed Handheld Terminal/Data Logger
3. 2 batteries (type AA)
4. USB cable
5. software

Hand Held Digital Pyranometer:

In this instrument Two pyranometer sensors (Shortwave / Global Radiation (Choose Any one)) one upward and one downward will be attached with this handheld terminal for the collection of real time data Manually/automatically (user selectable). The terminal has its internal memory along with, a real time clock with an LCD (16 X 2) to display the instrument status. It is a self- contained power source system, fitted with 2XAA Alkaline type batteries with battery level display, complete with sensor .

Deliverables

1. Two Pyranometer Sensor with 1m cable length
2. Programmed Handheld Terminal/Data Logger
3. 2 batteries (type AA)
4. USB cable
5. software

Digital Solar Radiation Recorder:

"Virtual" make Solar Radiation Recorder reflect state of the art in micro controller-based instrumentation design. The Solar Radiation Pyranometer sensor (Shortwave / Global Radiation (Choose Any one)) will be attached with this data logger for the collection of real time data automatically.

Sensor Type: Pyranometer Sensor for Shortwave / Global Solar Radiation

Parameter Monitored: Date, Time, Solar Radiation (W/m^2), Battery Voltage.

Display: 16 Characters X 2 Lines alphanumeric display,

Keyboard: 4x2 membrane keypad for onsite programming of data logger.

Real Time Clock accuracy: Internal with ± 2 minutes / year & leap year compensation

Number of Channels: Eight (extendable up to 16 at extra cost).

Along with Small Stainless Steel Tripod, Data Output Format: MS- Excel

Data retrieval: Data shuttle (default) to Computer. Other options (Ethernet / GPRS) also available (at extra cost).

Albedo Measurement is also available at Extra Cost



Solar Tracker (Dual Axis):

The dual axis solar tracker (Model No.: V-SOL-2A2P) is an all-weather positioning platform used to point specialized instruments/sensors at the sun's movement across the sky. It is fully automatic and does not require a computer or software installation to control the tracking of Sun movement. The integrated GPS receiver automatically configures location and time data. An RS-232 port allows for software upgrades. The high- efficiency gear drive system requires no maintenance. The tough and distinctive cast aluminum housing has an integrated tripod stand with leveling feet. A side plate with mountings for a pyrheliometer is included as standard and a second side mounted plate can be fitted for an additional pyrheliometer.

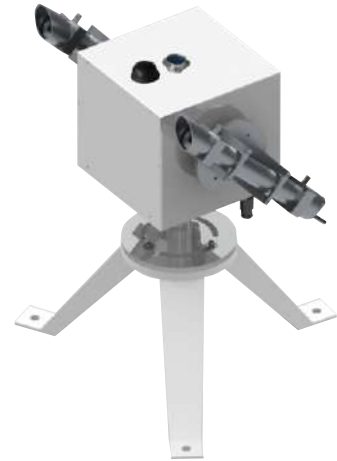

Sunshine Recorder:

The 'Virtual' make Sun-Shine Recorder is manufactured to a proven design and is of the type used extensively by meteorological services. Basic Main Components are bowls which are manufactured from Bronze as per IS:306:1968 and are precisely machined and assembled. The sphere bowl is made uniformed and well annealed and air bubble free glass having good surface finish. The instrument is always supplied with one year recording graph



Following are the Solar Measurement Sensors Available with us:

- Pyranometers (Shortwave / Global)
- Albedometers
- 2 / 4-Component Net Radiation Sensors
- Pyrgeometer
- Pyrheliometer
- Ultraviolet Sensor
- Infrared Sensor
- Quantum Sensor
- Line Quantum Sensor
- Fog Sensor
- Visibility Sensor
- Passive Cloud Cover

Wind Measurement

Anemometer Cup Type:

The 'Virtual' make Cup Type Anemometer measures total run of wind passing at the point of observation through Mechanical Counter of the range 0 to 9999.9 km with measuring range 0 to 1200 meter per minute. The counter unit is housed in a metal box with a top cover. Incorporated in the front is a window through which the digits can be observed.

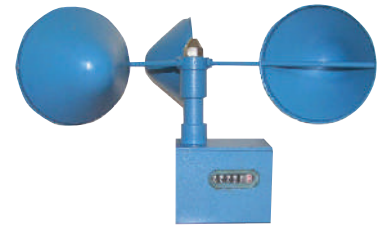

Wind Vane:

The 'Virtual' make Wind Vane is used for determining instantaneous wind Direction. Surface wind is best measured by a wind vane and anemometer. Wind direction is defined as the direction from which the wind blows and is measured clockwise from geographical north. Wind direction compass points from which direction the wind is coming e.g. south, southwest, west etc. The

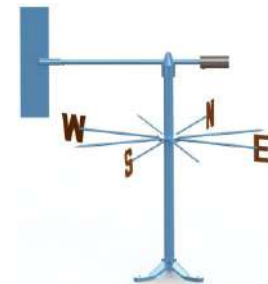

Digital Anemometer:

This instrument comes with dual digital display measures speeds from 5 mph to over 125 mph. The unique tilting head folds flat for storage. Water-resistant display can be used in heavy rain. Multi-function display, in mph or km/h. Displays Current Speed plus Average or Max speed at the same time.



Automatic Wind Monitor:

" Virtual" make Automatic Wind Monitor is a fully computerized, digital and self contained power source system, fitted with Data Logger and battery charging solar panel with rechargeable, maintenance free batteries complete with sensors mounted on a tripod stand with sealed waterproof enclosure for Data Logger, Solar charger and battery.

- Display: 16 Characters X 2 Lines alphanumeric display,
- Keyboard: 4x2 membrane keypad for onsite programming of data logger.
- Measured Parameter – Date, Time, Wind Speed, Wind Direction, & Battery Voltage.
- Mast: Default -Stainless Steel Tripod (SS). Optional – 3M SS /6meter GI Mast (at extra cost)
- Data retrieval: Data shuttle (default) to Computer. Other options also available (at extra cost).



Stevenson Screens



The 'Virtual' make Stevenson Screen, manufactured as per IS: 5948:1970, are standard shelter (from rain, snow and high winds, but also leaves and animals) for meteorological instruments, particularly Max., Min., wet and dry bulb thermometers used to record humidity and air temperature.

It is kept 1.2m above the ground by legs / Concrete Pillars to avoid strong temperature gradients at ground level, has louvred sides to encourage the free passage of air, and is painted white to reflect heat radiation, since what is measured is the temperature of the air in the shade, not of the sunshine.

Walls and floor of white-painted wood provide screening, and extensive louvres maintain adequate ventilation on all but the stillest days.

A screen is designed to provide an enclosure with a uniform temperature the same as that of outside air. It is completely surround the thermometers and exclude radiant heat and precipitation. The walls of such a screen should preferably be double-louvered and the floor is made of staggered boards. For Small & Large Stevenson Screen the roof is double-layered, with provision for ventilation of the space between the two layers.

Three types of screens are available

Mini –for Two vertical type meteorological thermometers

Dimensions: Mini screen

Width : 230 mm

Depth:130 mm

Height : 340 mm

Single / Small – for four meteorological thermometers

Dimensions: Small screen

Width (Between inner slots of louvers): 560 mm

Depth (Between inner slots of louvers): 315 mm

Height (Between middle of lower roof and floor): 412 mm

Double / Large – for thermograph and hygrograph

Dimensions: Large screen

Width (Between inner slots of louvers): 1325 mm

Depth (Between inner slots of louvers): 315 mm

Height (Between middle of lower roof and floor): 412 mm

Optional Accessories : Mounting Stand (to be purchased Separately)

for Small & Large Stevenson Screen

Height: 1.2 meter above Ground Level

Material: Mild Steel Angle with corrosion resistant Black Paint.



Evaporation Recorders

Open PAN Evaporation:

This is the instrument that measures the rate of evaporation of water into the atmosphere, sometimes called an atmometer. Evaporation rates are so sensitive to the water supply, and the nature of the evaporating surface, data collected by Evaporimeter often do not reflect true evaporation processes; hence, Evaporimeter have limited use.

This Open Pan Evaporimeter is manufactured as per IS: 5973:1970. The Pan is manufactured from painted GI sheet/ Copper tested for water leak proofness. The stilling well and thermometer clamps. This is supported on wooden platform painted white, Measuring Jar is manufactured from transparent Acrylic also available is brass.



Digital Evaporation Recorder:

“Virtual” make Digital Evaporation Recorder is a fully computerized, digital and self-contained power source system, fitted with Data Logger and battery charging solar panel with rechargeable, maintenance free batteries complete with sensors mounted on a tripod stand with sealed waterproof enclosure for Data Logger, Solar charger and battery. 16x2 alphanumeric display and 4x2 membrane keypad is provided at front panel of data logger for programming data logger and monitoring sensor reading at site without the help of computer. This system Comes with Auto Water Filling Option in PAN at extra cost.

Parameter Monitored **Date, Time, Level in Pan, Water Temperature (optional), Wind Speed (optional) & Battery Voltage.**

It comes with facility to transport Data from Data Logger to a Computer (Telemetry or Non-Telemetry).

Early Flood Warning System



Early warning systems are an important component of disaster risk management strategies. In controlled forecasting systems, which assess flood risk, the main purpose of early warning systems is to issue warnings when a flood is occurring. It uses a radar Level sensor for water level measurement in River and Rainfall Sensor as a base input parameter. This system has capability to incorporate Radar Velocity Sensor (Optionally at extra cost) for discharge measurement using discharge data to executive remote alarm.

Features:

- Non Contact Radar type Level Measurement
- Rainfall Measurement
- Discharge measurement (Optional at Extra Cost)
- Inbuilt Telemetric Data logger
- Dual Data Download Facility (USB & GSM GPRS)
- Online Data download through Webspaces
- SMS Alert Facility
- One Wireless Hooter Alarm Alert Provided in Down Steam
- System can be connected to more numbers of Wireless Hooters at Extra Cost
- Hybrid Power System: Works on 230 V AC & Solar Power

Mounting Mast & Solar Panel

- Mast: GI Mast with sensor brackets.
- Solar Panel: Output Voltage: 12 Volt DC, Wattage: 100 Watt (as per system power requirement)



Radar Water Level Sensor:
Measuring principle: pulse
runtime procedure
Measuring range: 0 - 15 / 35 mtr
Resolution: 1 mm



Tipping Bucket Rain gauge:
Collector area: 330 cm²
Range: 100mm / hour
Resolution: 0.20mm / 0.50 mm



GSM Remoter Siren / Hooter:
Ideal Audible Range: 3.25 kms
Motor: 0.5 HP
Impeller Size: 6 inches



Radar Water Velocity Sensor:
Measuring principle: Bidirectional
microwave velocity measurement
Range: ± 0.05 to ± 15.0 m/s
Resolution: 1 m/s

An arrangement of Two Post-paid GPRS-Active GSM SIM Cards is in buyer work of scope. There should be Network Coverage Availability at the installation site. For Data Access Free Web-space will be provided for 1year & will be chargeable afterwards.

Water Discharge Measurement



Ultrasonic Flow Meter (For Pipes):

With the advanced large scale integrated circuit technology, it is well suited to most industrial environments for continuous flow measurement of homogeneous liquid. Although the system was designed principally for clean liquid applications, the instrument is tolerant of liquids with small amounts of gas/air bubbles or suspended solids found in most industrial environments. The flow meter use state-of-the-art digital electronics and very powerful ultrasonic transducers to give high accuracy for pipe . We offer ultrasonic flowmeters that is used to measure fluids like water, oil, chemical liquid and other sound conducting liquid.

Applications in such fields as power plant (nuclear electricity, fire power and electric power), thermal power, heating, heat supply, metallurgy, mine, petroleum, chemical industry, food, medication

Pipe size range (1"~48")

Suitable for PVC, copper, stainless steel, carbon steel



Non Contact Open Channel Discharge Measurement System:

This is a non contact Solar Powered flow meter for open water channels / Rivers mounted above the water surface. It uses a radar velocity sensor and a Radar Level sensor for water level measurement. The two measurements and the dimensions of the cross section profile are used to calculate the discharge from the continuity equation (velocity-area method).



Parameterization of the measurement site, data logging, visualisation and data transfer is possible by using the browser based control and management user interface, which can be run in any standard web browser via PC

Velocity Sensor Range: 0.05 m/s to 15.0 m/s

Level Sensor Range: 0 - 15 / 35 meters



DischargeKeeper (Camera-based Discharge Measurement System):

The DischargeKeeper is an innovative product for the continuous measurement and storage of water level, surface velocity and discharge in rivers, irrigation furrows and wastewater channels using An IP Camera

- Camera-based measurement of water level, surface velocity and discharge
- Versatile camera mounting positions
- Non-intrusive system, reliably measuring during flood events
- Remote transmission of measurement data and proof images
- Real-time, in-situ discharge measurements and alarm
- More than a sensor: use augmented reality to add value to the data
- One Sensor will measure up to 300 meter wide River / Cannel
- Bridge is not required
- AI based system which will generate Auto Rating Curve of site
- Suitable for 24x7 Measurement
- Give you Data in Form of Numeric Value, Snap Short and Video
- Suitable for the measurement of Wave Height

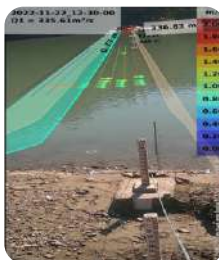

Suspended Solids Measurements

Portable Suspended Solids Indicator:

The suspended solids Indicator (Model:IPM) is a state of the art, easy to use meter that provides many benefits to the plant operations staff. It is a unique system that combines advanced electronics with a solid state, optical sensor. It is a multi-range indicator designed for the measurement of suspended solids in aqueous solutions. The microprocessor-based electronics of the indicator provide a high degree of flexibility and ease of use. Data logging and the ability to download the data directly to a computer are optional features



Features:

- Measuring range: 250 to 30,000 mg/L
- Infrared Sensor Technology
- Data logging
- Serial Interface to Computer Spread sheet
- Independent Calibration for MLSS & RAS
- Large, Backlit Graphical Display
- Water proof
- Rechargeable Batteries
- Real Time Clock

Suspended Solids Analyzer:

The Dual Channel Analyzer(DCA) is a unique system that combines advanced electronics with solid-state, smart sensors. The analyzer will accept any combination of two standardSS sensors and automatically configures for the correct operation. The system allows for flexible and economical process monitoring and control.



Standard Outputs:

- Two isolated 4-20 milliamps signals
- Two setpoint relays
- One setpoint or alarm relay
- One cleaning relay
- RS-485 ModBus RTU signal

Sensors Specifications:



- There are two ranges available.
- Measuring Range: M15 = 250 to 30,000 mg/l and M15L = 0 to 1,500 mg/l
- Accuracy: for M15 = +/- 5% of the reading or +/- 100 mg/l whichever is greater and for M15L = +/- 5% of the reading or +/- 2 mg/l whichever is greater
- Repeatability: +/- 1% of the reading or +/- 2 mg/l whichever is greater
- Response time: 95% in under 60 seconds

Ground Water Level Measurements

Ground Water Level Indicator / Sounder :

"Virtual Hydromet" make Water Level Indicator /Sounder is a reliable instrument for measuring the water level and total depth in boreholes, wells, reservoirs etc. For the measurement the bob is lowered to the water level. When touching the level, a sensor effects the illumination of a signal lamp & an additional acoustic signal will be released by a buzzer.



SN	Description	Model No.	Instrument
1	Water Level Sounder with 50m cable length	WLS-50	
2	Water Level Sounder with 100m cable length	WLS-100	
3	Water Level Sounder with 150m cable length	WLS-150	
4	Water Level Sounder with 200m cable length	WLS-200	
5	Water Level Sounder with 300m cable length	WLS-300	

Ground Water Level Recorder (Piezometer) :

"Virtual" make Ground Water Level Recorder (Non-Vented Piezometer) is reflect state of the art in micro controller-based instrumentation design. The Water Level sensor can be attached with this IP65 data logger for the collection of real time data automatically. The micro controller has its internal memory along with, a real time clock with an LCD (16 X 2) to display the instrument status. Comes with different ranges 10, 20, 50, 70, 100, 200, 300 meters. Data file is saved in Microsoft's Excel.

Parameter Monitored: Date, Time, Water Level, Water Table, Water Temperature, Barometric Pressure & Battery Voltage



SN	Description	Model No.
1	GWLR with Data Shuttle option	GWLR-NV-VH-P-D-XXX-YYY
2	GWLR with Ethernet option	GWLR- NV-VH-P-E-XXX-YYY
3	GWLR with GPRS enabled WEB-Based Telemetry	GWLR- NV-VH-P-GPRS-XXX-YYY

*XXX represents Measuring Range of the sensor (010, 020, 050, 070, 100, 200 or 300)

*YYY represents cable length of the sensor (020, 050, 070, 100, 200 or 300)



Water Level Measurements (Surface)

River Staff Gauge:

The staff gage is used for a quick visual indication of the surface level in reservoirs, rivers, streams, irrigation channels, weirs and flumes, and wherever accuracy and readability are important. Each gauge is accurately graduated and has grommeted holes for easy fastening to walls, piers, poles and other structures. Different models are available and per customer requirements



Digital Water Level Recorder (Float Type):

"Virtual" make Solar / Mains Powered data logger based Digital Water Level Recorder (Float type) reflect state of the art in micro controller based instrumentation design.

Sensor: Shaft encoder type water level sensor

Data logger for the collection of real time data automatically.

LCD display with Key on Data logger for the instrument status at field.

Telemetry or Non-Telemetry Options.

Data file is saved in Microsoft's Excel.

This instrument can also be used for Open channel, Dam and Lake level monitoring.



Digital Water Level Recorder (Pressure Type):

"Virtual" make Solar / Mains Powered data logger based Digital Water Level Recorder (Pressure type) reflect state of the art in micro controller-based instrumentation design.

Sensor: Piezo-resistive Pressure type water level sensor

Data logger for the collection of real time data automatically.

LCD display with Key on Data logger for the instrument status at field.

Telemetry or Non-Telemetry Options.

Data file is saved in Microsoft's Excel.

Comes with different ranges 10, 20, 50, 70, 100, 200, 300 meters

This instrument can also be used for Open channel, Dam and Lake level monitoring.



Digital Water Level Recorder (Non-Contact Radar Type):

"Virtual" make Solar / Mains Powered data logger based Digital Water Level Recorder (Radar type) reflect state of the art in micro controller-based instrumentation design.

Sensor: non-contact measuring principal type water level sensor

Data logger for the collection of real time data automatically.

LCD display with Key on Data logger for the instrument status at field.

Telemetry or Non-Telemetry Options.

Data file is saved in Microsoft's Excel.

Comes with different ranges 15, 35, 70, 120 meters

This instrument can also be used for Open channel, Dam and Lake level monitoring.



Digital Tide Gauge:

"Virtual" make Solar / Mains Powered data logger based Tide Gauge reflect state of the art in micro controller-based instrumentation design.

Sensor: Piezo-resistive Pressure and non-contact type water level sensor

Data logger for the collection of real time data automatically.

LCD display with Key on Data logger for the instrument status at field.

Telemetry or Non-Telemetry Options.

Data file is saved in Microsoft's Excel.

This instrument can also be used for Tide Gauges in Sea Shore.



Water Current Meters

The velocity of flow at any point in the open channel can be most accurately and conveniently determined by means of an electro / mechanical device named current-meter. Current-meter of common use may be classified in two categories according to the type of revolving part used.

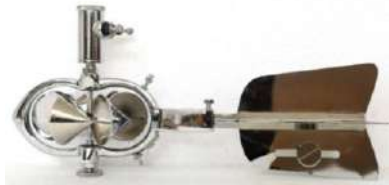

- **6 Cup Wheel Cup type (As per IS: 3910-1992):**
- Current meter body: All parts of brass, chrome plated
- Range: 0.3 to 3.5 meter per second (Extend to 5 m/s @ extra Cost)
- Accuracy: For velocities up to 0.3 m/s, 1% FS, For >0.3 m/s, 0.5% FS
- Contact chamber: Magnetic
- Dimension: Bucket Open end diameter: 2.0-inch, Bucket diameter: 5.0 inch
- Rates spin test: > 75 seconds
- Accessories: Instrument oil, cleaning cloth, screwdriver with 10kg fish weigh, 10m suspension wire and a rugged carrying case.



- **Propeller Type (As per IS: 3910-1966):**
- Current meter body: All parts of brass, chrome plated
- Range: 0.3 to 3.5 Meters per second (Extend to 5 m/s @ extra Cost)
- Accuracy: For velocities >0.3 m/s, 0.5% Full scale
- Accessories: Instrument oil, cleaning cloth, screwdriver with 10kg fish weigh, 10m suspension wire and a rugged carrying case.



- **Pygmy Type (For Small Streams):**
- Current meter body: All parts of brass, chrome plated
- Operating Range: 0.3 to 3.5 meter per second
- Accuracy: For velocities upto 0.3 m/s, 1% FS, >0.3 m/s, 0.5% FS
- Contact chamber Magnetic
- Dimension Bucket end diameter: 2.0 inch, > 75 seconds
- Rates spin test
- Accessories: Instrument oil, cleaning cloth, screwdriver with wading Rod rugged carrying case.



- **Universal Water Current Meter :**
- German Sensor
- Propeller Rotation Diameter: 120 mm,
- Propeller Hydraulic Pitch: 250 mm,
- Starting Velocity: <0.036 m/s,
- Velocity Measuring Range: 0.04 m/s ~ 10 m/s,
- Meter Body: Material high Quality non-corrosive
- Accessories: Instrument oil, cleaning cloth, screwdriver with wading Rod rugged carrying case
- Manual direction indicator is also available @ extra Cost



- **Flow Probe :**
- Diameter: Ø 60mm
- Measuring range 0.1 m/s – 10 m/s
- Minimum sensitivity <0.3km/h - <0.1m/s
- Accuracy ± 2% FS
- Accessories: 1.2m aluminium telescoping rod with 2m cable and Digital Display



- **Non-Contact Water Current Meter :**
- Operating temperature range -20 ~+70
- Relative humidity range 20%~80%
- Storage temperature range -30 ~70
- Measuring range 0.03~20m/s
- measurement accuracy ±0.03m/s
- Angle compensation Horizontal and vertical angle
- 2000 measurement results
- Standby state (at 25 °C) More than 6 months
- Continuously working More than 10 hours
- Accessories: Small Tripod Kit

Details of Digital Readouts for Water Current meters (Mandatory Item) is given below. Please choose any one. Used with Cup type, Propeller type, Pygmy Type & Universal Water Current Meters



Revolution Time Counter (Model: RTC-K23-D):

- Double Digit, Full LCD with Backlight, No Moving Part
- Protection: IP64, Battery Level Status
- Programmable Revolutions or Averaging Time.
- Measurement completion status (Blinking screen reading)
- Portable, hand-held easy to use.
- User Friendly Menu driven programmable functions.
- Max Revolution: 999, Max Time Count (Sec): 999
- Battery Life: 400 Hrs on 3 x AA Zinc Carbon Battery & 16 Hrs on 3 x AA Zinc Carbon (with Backlight)



Water Velocity Logger (Model: DVI-K20):

- 16X2 LCD with Backlit & contrast adjustment.
- On-site Menu driven controls using 4X2 keys keyboard
- Any Pulse generating water current meter can be used with DVI-K20.
- Internal Buzzer provided for current meter revolutions recognition.
- Programable up to 5 nos current meter calibration equation.
- For each current meter 3 equations can be programmed for entire velocity range.
- Can be used for 8 Site locations with different Site ID's.
- Site ID can be programmed for separate current meters as well.
- Data Storage facility: Greater than 5000 Datasets. Automatically logs data after completion of measurement.
- Computer / Laptop connectivity via USB with PC software.
- Data file will be saved in MS-Excel file format.
- Runs on 2 X AA type Zinc Carbon Batteries (Site replaceable)



Portable Water Velocity Logger:

This is a compact, Multichannel, battery-powered logger. It logs velocity data of all 8 channels simultaneously. It is useful for flow surveys, I&I studies, stormwater, irrigation water and sewage studies

- Data file format: MS Excel
- Programmable Selection of number of current meters
- Programmable Calibration curve of current meters
- Programmable Selection of display
- Programmable Selection of propeller velocity or water velocity
- Programmable Averaging period
- Self checking features, Low battery indication
- Audio Beep on every event



Bridge Outfit:

"Virtual" make Bridge Outfit Measuring Crane is manufactured as per IS 6064 1971. This equipment is useful for lowering and lifting heavy instruments like-current meter with fish weight for measuring stream velocity and obtaining sediment studies from the road bridge sites or from boat amid the rivers. The crane is easy to operate & maintain. It is made of aluminum / Mild Steel structure. The rear assembly is adjustable in a vertical direction so that the platform surface will remain parallel with the road surface when operated on sidewalks.

Samplers

Bed Load Sampler:

The bed-load Sampler is used to measure bed load of coarse sand and fine gravel in rivers and in other watercourses.

The simplest and most practical method for measuring the weight of bedload passing a section in a given time would be to collect the sediment for a given time in some kind of portable sampler; this method has been used in most efforts to measure the bedload discharge



Depth-Integrating Suspended- Sediment Sampler: Model USDH-48

This is a lightweight sampler for collection of suspended-sediment samples where wading rod sampler suspension is used. The sampler consists of a streamlined aluminum casting, 13 inches (33 cm) long, which partially encloses a pint (0.47 liter) sample container (sold separately).

Depth-Integrating Suspended- Sediment Sampler: Model USDH-59

These are medium-weight suspended-sediment samplers for hand line or sounding reel suspension. The DH-59 sampler comprises a streamlined bronze casting, 15 inches (38 cm) long, which partially encloses a pint-size (0.47-liter) sample container (sold separately). This sampler weighs approximately 22 pounds (10 kg), and is equipped with a tail vane assembly to orient the intake nozzle of the sampler into the approaching flow as the sampler enters the water



Ground Water Sampler:

The ground water sampler (Model: GWS-1) has technically been designed for the application in connection with the water level indicator. With this combination-design, it is possible to obtain liquid samples from any desired depth. Basically, the liquid sampler consists of three parts piston, tube and releasing weight. In order to get a liquid sample, the tube is hooked above the piston first and then lowered. When the desired sampling depth is reached by means of the measuring tape, the weight on top is released, which slides downwards along the cable to the top of the tube. Here, the closing mechanism is activated and the tube is automatically slid over the pistons. The liquid sample can now easily be pulled out by means of the supporting drum and the liquid withdrawn by the attached faucet



Suspended Sediment Sampler (Punjab Type):

This is the most common type of suspended sediment Sampler it consists of a metallic one litre capacity bottle held vertically in the metallic frame at one of a adequate length of pipe with lever attached to the lower end and a flexible wire running with the help of one spring and lever for opening and closing the mouth of bottle fitted with rubber cock during sampling

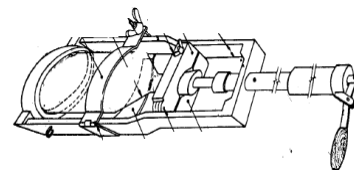

Unmanned Surface Vehicle :

This is a compact multipurpose UAV It can host all types of payloads, in order to meet needs related to :



- Hydrography
- Water Analysis
- Engineering Inspection
- Scientific Research
- Search & Rescue

Fast and easy deployment : It can be transported in the trunk of the car or a small van. Easy to deploy and recover from the water.

Coast reduction : Reduction of operating costs. one-man operated. Reduction of maintenance costs. electric propulsion and duty components.

No human risk : Unmanned. fully operated from the ground. Access to confined spaces, shallow waters or hazardous areas.

Automation : Semi-autonomous system. it can be used manually or with autopilot. Real-time data from the ground, or even from the office if 4G/LTE connection is available

Friendly : Easy to use. a very fast learning curve with our 1-day training plan. Respectful of the environment. fully electric, no fluids, non toxic materials.

USV for surface cleaning :

It can capture and remove floating waste, solids and hydrocarbons from following



- Marinas
- Harbours
- Lakes
- Reservoirs
- Industrial ponds
- Artificial lagoons

Soil, Plant Sciences & Forestry



Plant Canopy Analyzer :

'Virtual' make Plant Canopy Analyzer offers convenient and flexible tools for measuring and analyzing incident and transmitted Photo synthetically Active Radiation (PAR) in Crop and Forest canopies. It provides vital information about the penetration of PAR into crops and forest, and is essential in work such as comparative crop studies, for separating out the effects of cultivars and treatment. It is particularly well suited to low regular canopies (as found in many agricultural crops).

Parameter Monitored: Date, Time, Incoming PAR, Diffuse PAR, LAI.

Data logger based Portable System

Data Output Format MS- Excel



Automatic Leaf Wetness Recorder :

'Virtual' make Plant Canopy Analyzer offers convenient and flexible tools for measuring and analyzing incident and transmitted Photo synthetically Active Radiation (PAR) in Crop and Forest canopies. It provides vital information about the penetration of PAR into crops and forest, and is essential in work such as comparative crop studies, for separating out the effects of cultivars and treatment. It is particularly well suited to low regular canopies (as found in many agricultural crops).

Parameter Monitored: **Date, Time, Leaf Wetness, Air Temperature, RH & Battery Voltage.**

Solar Powered Data logger based System

Data Output Format MS- Excel

GSM GPRS Based Telemetry option available at Extra Cost



Ceptometer:

'Virtual' make Ceptometer offers convenient and flexible tools for measuring and analyzing incident and transmitted Photo synthetically Active Radiation (PAR) in Crop and Forest canopies. It provides vital information about the penetration of PAR into crops and forest, and is essential in work such as comparative crop studies, for separating out the effects of cultivars and treatment. It is particularly well suited to low regular canopies (as found in many agricultural crops).

Parameter Monitored: Date, Time, Incoming PAR, Diffuse PAR, Leaf Area Index.

Data logger based Portable System

Data Output Format MS- Excel

Smart Irrigation System :

- Remote Control : Precisely control your farm 24x7 from my SICCA app
- Planned Irrigation : Automation by scheduler/ timer and soil moisture sensor
- Protection & Management : Protect pump and Regulates Irrigation automatically
- Precision Farming : Monitor & control micro-climatic parameters using sensors
- Saves upto 80% Time & Effort Remotely control the farm's irrigation and fertigation from anywhere in a well-planned manner using a mobile phone without worry or physical hardships
- Saves upto 60% Water Schedule and manage irrigation activities from your mobile app and precisely irrigate using root-zone soil moisture sensors
- Saves upto 50% Fertilizers Appropriate irrigation through SICCA system prevents nutrient leeching
- Increases upto 40% Yield Precise and optimized irrigation and fertigation as per the crop need results in improved yield while also improving the immunity of the crop





Soil Tensiometer (Gauge Type):

'Virtual' make tensiometer measures the force with which water is held in the soil by the soil particles. The basic components of a tensiometer include a porous ceramic cup, a plastic body tube, and a vacuum gauge (Sold Separately).

The tensiometer is available in a variety of lengths, ranging from 15 cm to 90 inches. Service kit required with Soil Tensiometers (Sold extra). One Service Unit will service multiple instruments



Soil Suction Lysimeter :

The suction lysimeter is a cylindrical device consisting of a porous ceramic cup (to withdraw soil pore water using a vacuum); a body tube to act as a reservoir; and a simple stopper assembly with a single hole for pulling a vacuum and retrieving the sample.

We offers three different lengths: 30 cm, 60 cm, or 90 cm.

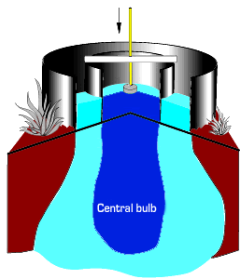

Double Ring Soil Infiltrometer :

The double ring Infiltrometer is a simple instrument which is used to determine the infiltration rate of water into the soil. The infiltration rate is determinate as the amount of water per surface area and time unit, which penetrates the soils.

The instrument consists of two concentric rings, driving plate, for inner and outer rings. The outer ring (ID = 45 cm); the inner ring (ID = 30 cm). The rate can be calculated on the basis of the measurements and the DARCY'S



Digital Soil Infiltrometer:

The Digital Infiltrometer is a simple instrument which is used to determine the infiltration rate of water into the soil. Now, a field instrument to measure the rate of water infiltration on all areas. This instrument determines the downward flow of water through the turf and soil

Inner ring diameter (ID) of 2 3/8 inches (6.03 cm)

Inner ring height 7 inches tall (5 inches (12.7 cm) of water on top of the soil when inserted to depth limit ring

Inner ring hold approximately 0.5 L (When inserted into soil)

Inner ring surface area = 11.176 cm²

Outer ring diameter (ID) of 4 1/4 inches (10.79 cm)

Outer ring height 6 inches tall (4 inches (10.1 cm) of water on top of the soil when inserted to depth limit ring

Outer ring hold approximately 0.75 L (When inserted into soil)



Soil Permeability Apparatus :

Soil Permeability Test Apparatus is a property of soil that permits the flow of water through its interconnecting voids.

Soil Permeability Apparatus comes with glass tubes of 75mm, bore tube is provided with overflow arrangement for constant head tests. The remaining tubes are used for falling head test.

STANDARD: IS 2720 (PART-XV), IS:12287, BS:1377, ASTM D2435

Soil, Plant Sciences & Forestry



Digital Soil Moisture Meter :

The 'Virtual' make Digital Soil Moisture Meter, used with the Soil Moisture Sensor and Soil Temperature Sensors (Optional), make up a valuable system to monitor the soil moisture & temperature available in your soil.

You can use as many sensors as you like at representative sites. Then, using the Digital Soil Moisture Meter you can read each sensor individually as frequently as necessary. The importance of water to plant growth is well known.



Soil Moisture & Temperature Recorder :

'Virtual' make Soil Moisture Temperature Recorder offers professional Soil monitoring and good value for money. The standard Soil Moisture Temperature Recorder consists of a weatherproof enclosure, which contains the data logger and power supply, and comes complete with a solar panel, tripod stand and Soil Moisture Sensors (Watermark) & Temperature sensor.

Sensor Input: Seven Soil Moisture & One Soil Temperature Sensor

Sensor can be extended up-to 8-Soil moisture & 8-Soil Temperature Sensors (at extra cost)

Parameter Monitored: Date, Time, Soil Moisture suction in Centibars & Soil Temperature in °C, Battery Voltage.

GSM GPRS Based Telemetry Option available at Extra Cost



Soil Moisture, Temperature & EC Recorder :

'Virtual' make Soil Moisture Temperature Recorder offers professional Soil monitoring and good value for money. The standard Soil Moisture Temperature Recorder consists of a weatherproof enclosure, which contains the data logger and power supply, and comes complete with a solar panel, tripod stand and Soil Moisture, Temperature & EC sensor.

Sensor Input: Eight Soil Moisture, Temperature & EC sensor

Parameter Monitored: Date, Time, Soil Moisture, Temperature, EC and Battery Voltage.

GSM GPRS Based Telemetry Option available at Extra Cost



Digital Soil Moisture, Temperature and Salinity Meter :

EC-350 Digital Soil Moisture, Temperature and Salinity Meter displays soil moisture percentage, soil temperature °F, and soil salinity cS/m. May be used in a variety of soils, and is unaffected by temperature, pH, dissolved salts, or metallic ions.

Simply insert probe at least six inches into reasonably soft, moist area and press appropriate test button. Results appear quickly. Rapidly perform multiple tests at various depths and locations. Just wipe off probe after each test. Features 30" stainless steel probe, clay, loam and sand scales printed on meter's face panel, and soft foam handles. Informative user's guide and 9V battery included.



FieldScout TDR 350 Soil Moisture Meter :

The TDR 350's shaft-mounted probe allows the user to take measurements while standing. The meter's built-in data logger can record data from several sites and eliminates the need to record data manually. The data points can be viewed with the FieldScout Mobile app that maps out soil measurements using logged GPS locations. Measurements can also be saved to a USB drive that is plugged into the built-in USB port. TDR rods are sold separately

Measurement Units Percent volumetric water content (VWC) Period (raw sensor reading)

Major Clients / Users



ISRO



Uranium Corp of India Ltd



DRDO



Indian Navy



Indian Air Force



Indian Railways



Konkan Railways



Central Water Commission



BHEL



A Maharatna Company
NTPC



NHPC



SJVN



UJVNL



NEEPCO



टीएचडीसी इंडिया लिमिटेड
THDC INDIA LIMITED



CSIR



ICAR



GBP University



IIT Khadagpur



IIT Guwahati



IIT Kanpur



IIT Bombay



IIT Madras



IIT Roorkee



IIT Delhi



Anand Agriculture University



NERIST



Tezpur University



NEHU, Shillong



NIH, Roorkee



Tata Group



Maruti Suzuki Ltd



CSA University of Agri & Technology Kanpur



J&K Forest



United Nations

Global Footprint of Virtual Group



Contact Details :



Business Center, SPC Free Zone, AI Zahia, Sheikh Mohammed Bin Zayed Road, Sharjah UAE
Email: sales@vhydromet.ae, Web: www.vhydromet.ae, Botim / Whatsapp: +91-9412072697